



# OPERATOR'S MANUAL

## Accu-Cut X-33

Carpet & Vinyl Cutting and Rolling Machine



**For Parts or Service contact  
Accu-Cut Support 1-800-222-8288**

**Brockie International Inc. 28114 County Road 561, Tavares, Florida 32778**  
voice 800.222.8288 • 352.742.0902 fax 352.742.0702  
info@accu-cut.com • www.accu-cut.com

# CONTENTS

<b>INTRODUCTION .....</b>	<b>3</b>
<b>SAFETY PRECAUTIONS .....</b>	<b>4</b>
<b>ABOUT THE MACHINE .....</b>	<b>5</b>
<b>OPERATING PROCEDURES.....</b>	<b>6</b>
Loading the material-----	6
Adjusting the shuttle cradle .....	6
Adjusting the size of the load cradle .....	6
Unwrapping new & tightening loose rolls .....	7
Positioning the material .....	7
Keypad familiarization-----	8
Password protection-----	8
Setting preset length-----	9
Rolling the product .....	9
Cutting the product .....	9
Carriage control-----	10
Multiple scale factors .....	10
Master user's menu .....	10
Password menu .....	11
Auto fold-up menu .....	11
Cut counter .....	11
Calibrating the machine .....	12
Auto calibration .....	12
Mid cradle stop .....	12
Reverse rolling .....	13
<b>MAINTENANCE .....</b>	<b>14</b>
<b>PREVENTIVE MAINTENANCE .....</b>	<b>15</b>
<b>CIRCULAR CUTTER MAINTENANCE .....</b>	<b>16</b>
<b>TEST STRIP INSTRUCTIONS.....</b>	<b>17</b>
<b>TROUBLE SHOOTING .....</b>	<b>18</b>

# INTRODUCTION

Congratulations on the purchase of your **Accu-Cut X-33** carpet and vinyl cutting and rolling machine. Your Accu-Cut machine has been carefully engineered and manufactured to provide you with many years of dependable service and trouble free operation.

Proper operation and maintenance is essential to ensure precise and dependable operation of your Accu-Cut. We encourage you and your employees to read this manual carefully and become familiar with the operating and maintenance procedures for this machine.

This manual is designed to cover all areas of operation, maintenance, and troubleshooting in order to minimize problems. Always follow all safety rules and precautions when operating or performing maintenance work on the machine.

Again, congratulations and thank you for choosing Accu-Cut to provide you with quality equipment and quality service. The confidence you and thousands of others have placed in us has helped to make Accu-Cut the most respected name in floor covering cutting equipment. Should you ever have any questions or concerns regarding your Accu-Cut please do not hesitate to contact us.

# **SAFETY PRECAUTIONS**

In order to avoid personal injury, make sure the operator(s) and/or maintenance person(s) of the machine have been oriented with the machine's operating procedures and are aware of all safety precautions.

- 1. Unplug power cord before making any adjustments or repairs.**
- 2. A qualified electrician should perform electrical repairs.**
- 3. Do not operate machine on a wet floor.**
- 4. Use extreme caution when replacing cutter blades.**
- 5. Keep hands clear of all moving components while machine is running.**
- 6. Keep loose clothing and articles away from all moving components while machine is running.**
- 7. Keep machine unplugged while not in use.**
- 8. Do not allow children near the machine.**
- 9. Keep machine clean of all plastic wrap, carpet fibers, and all other debris.**
- 10. Ensure machine is stationary and will not roll on casters.**
- 11. Stay clear of moving load side shuttle cradle.**
- 12. Do not remove chain covers except for servicing.**
- 13. Keep space beside cradles (dumping areas ) clear.**

# ABOUT THE MACHINE

The **Accu-Cut X-33** cut and roll machine consists of two sets of steel rollers that are referred to as cradles. The side where material is loaded is the **load side cradle**, while the opposite side is the **roll up cradle**. The roll up cradle is designed to run slightly faster than the load side to ensure a tight roll up of material. Each cradle is chain driven by heavy duty UL & CSA approved electric motors.

The X-33 is operated from the **control panel**, which includes the **directional controls**, **variable speed control** and the Programmable Logic Control or **PLC Interface display** which houses the **foot & inch counter**, **shuttle cradle control** as well as other advanced controls.

The **Accu-Cut X-33** measuring system is extremely accurate. It consists of a large diameter, knurled **measuring wheel** located in a cutout of the **inspection table** below the **hold down arm**. The measuring wheel is connected to an advanced encoder that emits 600 pulses per revolution. The encoder communicates with the foot & inch counter in the PLC to provide you with an accurate measurement.

The cutter assembly on the X-33 consists of 5 1/2" circular blade positioned within a cutter assembly inside the **cutting track**. The X-33 also has a **cutter bar** that not only covers the blade while making a cut but also holds the material tight. The cutter assembly is chain driven by a dedicated cutter motor.

The circular blade is self sharpening.  
(see *sharpening blade on page 10 for details*)

A wrap around **foot control cable** is provided to operate the machine "hands free" while inspecting wrapping, unwrapping, or tending the roll. It can be set to be on only when you step on the foot cable or as a toggle so the machine stays in an on position.

The X-33 also includes a **dumping mechanism** on both the **load side cradle** and **roll up cradle** that will quickly and simply offload the material onto the floor allowing another roll to be loaded without removing the goods with a forklift. The **load side dumping mechanism** is particularly useful when used in conjunction with a feed table.

# OPERATING PROCEDURES

## PROCEDURES FOR UNROLLING AND CUTTING

### Loading the material

Place the material on the **shuttle load cradle**, making sure the leading edge of the material is feeding across the **inspection table** from the **bottom of the roll** with the **pile side up and the backing down** – vinyl can be measured pattern up or down. Place the roll in the cradle with the end of the roll just past the last belt on the front end of the cradle



Photo 1A

### Roll-Improver

This feature is useful to position the roll in the load cradle, as well as squaring the leading edge to the cutting line. In normal operations make sure the roll improver is down at both ends while roll is rotating. By moving either end of the roll improver up and squeezing the roll at the same time you can cause the roll to walk to the front or back of the load cradle, when the roll is positioned ensure that both ends of the roll improver are down. When the leading edge of the material is off square you may adjust this by activating the roll improver as well as the amount of squeeze on the roll in the load cradle. Make sure that the roll improver is back in the lower position after material has traveled several feet



Photo 1B

### Adjusting the size of the load cradle

The size of the **load cradle** can be adjusted by moving the **load side dumping mechanism** and altering the position of the outside roller. Adjusting the size of this cradle to a size consistent with the diameter of the material provides the operator with greater control over the material, by squeezing the roll it keeps the roll squared to the cradle.

### Adjusting the shuttle cradle

The X-33 is equipped with a **shuttle cradle** that can be used to properly line up the material on inspection table. The edge of the material should be within a few inches of the bumper at the front of the inspection table. The shuttle load cradle can be manually adjusted by arrow (Photo 1B) buttons on the interface.



Photo 1C  
Shuttle Cradle Forward Position



Photo 1D  
Shuttle Cradle Back Position

## Unwrapping new rolls and tightening loose rolls

After loading the wrapped roll, cut the plastic the full length of the roll and at each end. Position the load cradle **roller directional switch** in the reverse position, and then step on the **foot cable control** while pulling off the plastic wrapping.

If you have a loose roll, run the **load cradle** rollers in reverse by placing the load cradle **roller directional switch** in the reverse position and pressing the **jog button** or stepping on the **foot cable control** to activate the load cradle rollers. Continue to run the rollers in reverse until the roll has tightened.

## Positioning the material

Raise the **hold down arm**, lifting it off the **measuring wheel**. Set both **roller directional switches** to forward. Step on the **foot cable control** or press the **jog button**, advancing the material to the center of the **cutting track** (see photo 3A). Now lower the **hold down arm** back on to the **measuring wheel**. Failure to lower the **hold down arm** will result in an inaccurate measurement.



Photo 3A



Photo 3B

**Note:** If the material is off square, line the trailing edge of the material with the **cutting track** (see photo 3B).

## Keypad Familiarization



- Blue Keys- Carriage control
- Green Key- Go autorun
- Red Key- Stop autorun
- Yellow Key- Counter up / down
- Orange Keys- Scroll product
- Pink Key- Scroll scale factor
- Red/Yellow Key- Sharpen blade
- Grey Key- Master Password
- Grey Key- Roll Balance
- Numeric keys- Data entry

### ***Password Protection***

This unit is equipped with a “Password Protection” feature. Every time the machine is turned off or is unused for a designated time the machine prompts the user to

“ENTER PASSWORD”

\*\*\*\*

- To enter the password:
1. Press MOD to remove asterisks
  2. Type in the four digit security code (Factory preset is “4321”)
  3. Press ENTER

You have now gained access to the machine and may begin to roll, measure and cut the product.



## ***Setting Preset Length***

This unit is equipped with a multi-preset feature that enables the user to enter the required length of material into the machine's memory. This will prompt the machine to automatically slow down the rolling process approximately one foot before the desired length has been reached. It then slowly rolls to the preset length.

- To enter a preset length:
1. Press MOD to erase the previous measurement
  1. Type in the desired amount of feet & inches  
(last 2 digits are inches if imperial or centimeters if metric)
  3. Press ENTER

Your desired length is now entered into the counter. You are now ready to roll and cut the product.

## ***Multi-Cutting***

This unit is equipped with nine pre-programmable lengths. You now have your first preset selected. To change to another preset press SCROLL PRESET up or down. This will change your preprogrammed length. Press clear to change the pre-programmed length. . To program all 9 presets simply repeat the procedure described in "Setting Preset Length". Once you have completed this, the lengths are stored in the memory of the machine and remain present even when the machine is unplugged. This feature is very useful when cutting a series of same size pieces for a given house plan for example.

## ***Rolling the Product***

### **Manually**

1. Load carpet on load side of cradle
2. Set all switches to desired position
3. Advance the carpet to the middle of second roller on IVC 15  
(the counter will reset itself automatically)
4. Lift the roll-up cradle
5. Run the machine until desired length appears (reverse direction if necessary)

### **Automatic**

This machine is capable of rolling automatically to a stop without having a finger depressed on the jog button (although the user must always pay full attention to the machine).

1. Load carpet on load side of cradle
2. Set all switches to desired position
3. Set desired length
4. Press the green GO button

## ***Cutting the Carpet***

Now that you have accurately measured the carpet you are ready to proceed with a cut.

1. Press the green cut button.  
(A beep provides the user with a warning that cut is being performed)
2. Press the green cut button a second time.  
(the cutter will run the length of the table cutting the carpet)

Should you ever wish to stop the cutter press the red abort cut button.

### **Carriage Control**

Your machine is equipped with a movable carriage which may be adjusted through the interface either manually or automatically. When carpet is initially brought on the table the carriage defaults to auto mode. To switch from manual to automatic or a, press the carriage auto/manual button to toggle the condition.

In manual mode press CARRIAGE OR CARRIAGE to move the load towards or away from the operator. In automatic mode the electric eyes on the machine adjust the load automatically.

### **Multiple Scale Factors**

Sometimes different products grip the count wheel differently due to their adhesive nature. We have taken this into consideration by allowing this machine to retain six separate scale factors to accommodate a variety of materials. Different product may be selected at any time by pressing SCROLL PRODUCT. This changes the screen to display another product.

Examples of different presets measuring differently:

	IMPERIAL			METRIC	
Scroll product once:	CUT 1	0'	0"	CUT 1	0CM
	CARPET 1	20'	0"	CARPET 1	608CM
Scroll product twice:	CUT 1	0'	0"	CUT 1	0CM
	CARPET 2	19'	10"	CARPET 2	603CM
Scroll product thrice:	CUT 1	0'	0"	CUT 1	0CM
	CARPET 3	20'	1"	CARPET 3	611CM
			(etc...)		

### **Master User's Menu**

This counter may be tailored to better suit the user of the machine. When the password button is depressed a MASTER PASSWORD is brought up.

MASTER PASSWORD  
\*\*\*\*\*

- To enter the master password
1. Press MOD to remove asterisks
  2. Type in the 4 digit master password
  3. Press ENTER

Upon entering the correct password you now have gained access to the Master Users Menu.

Press the left arrow to navigate through the menu or escape to back up.

## ***Password Menu***

On this unit the user may change his password and/or the time at which the machine locks the user out if left unattended for your convenience. If 0 is entered in the timer, the timer and password are disabled.

To access password menu:

1. Access master menu
2. Scroll through till you find the Password Menu

To enter a new password:

1. Scroll to: Enter New Password
2. Press MOD to remove old password
3. Type in a new password
4. Press ENTER

To change the timer value

1. Scroll to: Enter New Timer
2. Press MOD to remove old timer value
3. Type in the desired time in seconds
4. Press ENTER

You have now changed the length of time the machine requires before it turns itself off without input.

Factory preset is 120 seconds. If the machine will be located in a publicly accessible location we recommend a time of 15 seconds. The operator should never leave the machine unattended while the password is active and the cutting blade is in the garage. The manufacturer or its agents cannot be held responsible for any injuries to anyone of any kind howsoever caused. The operator is solely responsible for safe operations and mechanical and electrical condition of the machine at all times.

## ***Auto Fold Up Menu***

When this machine is in auto mode the fold up cradle is capable of opening and closing automatically. Materials differ slightly so it may be desirable to change the point at which the cradle opens and how long it opens (or closes) for.

To change the timer:  
(or length)

1. Access the master menu
2. Scroll till you find the Auto Fold Up Menu
3. Press MOD to remove old timer (or length) value
4. Type in the desired time in pulses
5. Press ENTER

## ***Cut Counter***

This is a helpful feature that counts the number of cuts you have made since you have owned your machine. It is useful to help gauge blade life expectancy.

## ***Calibrating the Machine***

The calibration of all 6 scale factors of this machine may be changed using the master menu.

**CAUTION:** Do not attempt to adjust the scale factor. For technical support please contact  
**Accu-Cut Service at 1-800-222-8288**

## ***Auto Calibration***

This option must be ordered from factory and is only present on models purchased with an 8ft or longer table.

## ***Mid Cradle Stop***

This is the point during the autorun sequence where the product stops in the center of the cradle.

To adjust the Mid Cradle Stop Point:

1. Access master menu
2. Scroll through till you find Mid Cradle Stop
3. Press MOD to remove old mid cradle stop point
4. Type in the desired time in pulses
5. Press ENTER

## ***Slowdown***

The user is now able to determine how many inches before completion the carpet cutting machine enters its slow down mode.

To access slow down:

1. Access the master menu
2. Scroll through till you find Slow Down Point
3. Press MOD to remove old Slow Down Point
4. Type in the desired point in pulses
5. Press ENTER

## PROCEDURES FOR REVERSE ROLLING

### Rolling up the material

After setting the **counter**, either press the **jog button** or step on the **foot cable control**. Place the paper tube in the roll-up cradle and advance the leading edge of the material until it reaches the second, big roller on the roll-up cradle (see *photo 14A*). Position the material on top of the tube.

Leave the load cradle **roller directional switch** in the forward position but place the **roll-up cradle roller directional switch** in the reverse position.

Close the **roll-up arm** and engage the rollers by stepping on the **foot cable control** or pressing the **jog button**. The **roll-up arm** will cause the material to begin rolling in reverse around the cardboard tube and start the roll-up procedure. (see *photo 14B*). After the material has made several revolutions open the roll-up arm. (see *photo 14C*).

**NOTE:** If the material is walking up on the inspection table momentarily shut off the roll-up cradle to allow load cradle to catch up.



Photo 14A

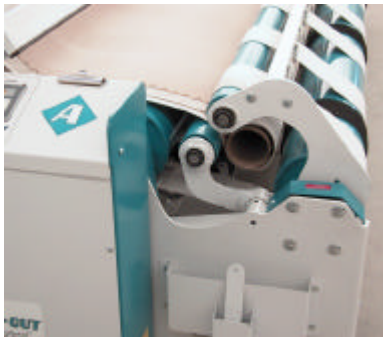

Photo 14B

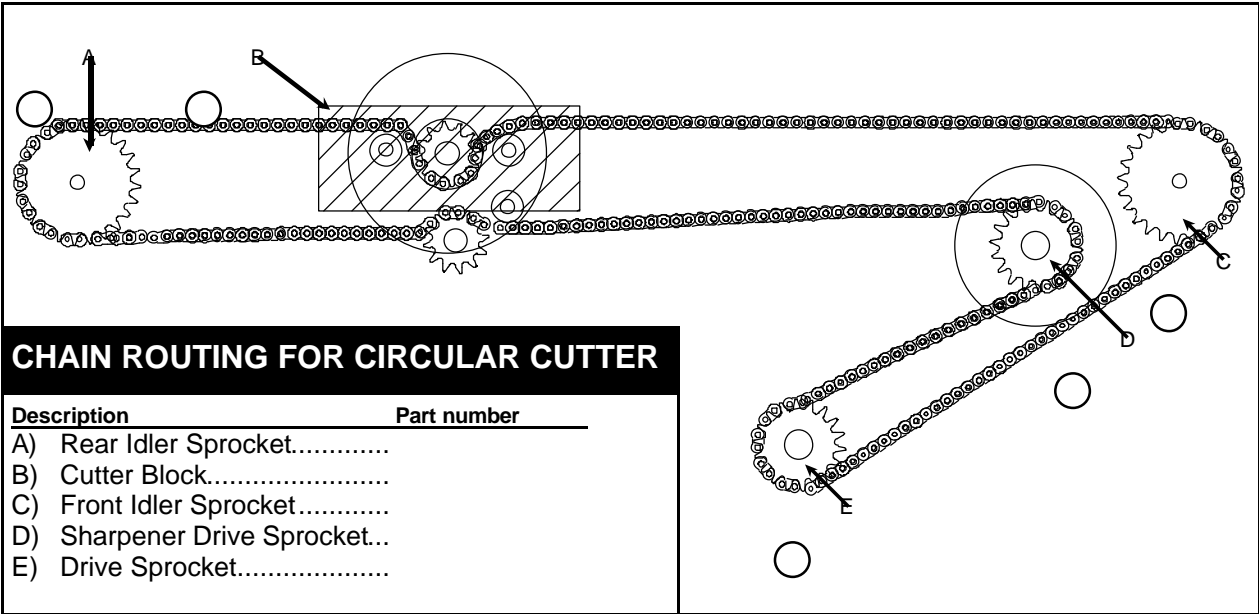

Photo 14C

# MAINTENANCE

## MAINTENANCE

- Drain water from water separator regularly.
- Keep cutting blade sharp. Replace sanding disks as needed.
- Check chain tensions periodically and tighten as needed. To check cutter chain tension, bring cutter 2 ft. from end of machine. Sag in the chain should not be more than 1" (25mm).



# PREVENTIVE MAINTENANCE

## Weekly:

1. **Check conditions of belts and belt lacing.** Repair, if possible, any damaged belt lacing contact Accu-Cut for replacement belts.
2. **Check control switches** for proper operation.
3. **Check operation of counter assembly.**
  - ◆ Check that measuring wheel is secure and does not have any cracks or excessive wobble.
  - ◆ Check the “grooves” or “knurls” on the measuring wheel. Ensure the wheel does not have smooth or bald spots.
  - ◆ Make sure wheel is at proper height above opening in the table. Wheel must be at least a credit card thickness above opening or the pads on either side of the opening.
  - ◆ Check condition of measuring wheel shaft and its connection to the counting device. Make sure the shaft is secure and not bent.
4. **Clean machine** of debris and/or carpet fibers, particularly on or around the motor areas, chains, sprockets and cutting track.
5. **Check tension on all cables and chains.** Adjust as necessary for proper operation.
6. **Check calibration of counter.** Follow the Test Strip Instruction sheet in this manual to check your calibration. Contact your Accu-cut Service Representative before attempting re-calibration.

## Monthly:

1. **Check the alignment** of all sprockets, pulleys and rollers for proper operation.
2. **Check allen screws** on all sprockets, pulleys and locking collars.
3. **Check condition of the electrical outlet** on machine. Ensure outlet is secure.
4. **Check gearboxes** for proper oil level. Use 90-weight gear oil, if needed.
5. **Lubricate all drive chains** with light oil.

## Yearly:

1. **Lubricate all roller bearings** with grease gun
2. **Lubricate all bearings for cutter drive assembly** with grease gun.
3. **Lubricate counter shaft bearings** with grease gun.
4. **Lubricate swivel castor wheels** with grease gun.

## CIRCULAR CUTTER MAINTENANCE

### How to perform maintenance on your cutter:

1. Remove blade from cutter assembly. Flush cutter block assembly and clutch mechanism, (white metal piece attached to bottom of the blue cutter block assembly), with an aerosol spray such as WD-40 or similar product. Run the cutter up and down table a few times to remove excess cleaner. Wipe dry as much as possible.
2. Use a Silicone or Teflon based spray to lubricate all moving parts of the cutter assembly. Avoid spraying Silicone into the bronze bushings of the clutch mechanism.
3. Clean blade and spray with silicone or Teflon spray.
4. Inspect pulleys and drive belt on cutter motor. Make sure the belt is in good condition, (no cuts, fraying or glazed look on its sides), and is kept tight at all times. Make sure there is no foreign matter on the pulleys or drive belt.

This procedure only takes about 10-15 minutes to complete. Depending on the amount of cuts you make a day will determine how often this procedure should be repeated.

**Example: 50 or more cuts a day – once a week.**

**\*Do not over tighten the cutter chain or clutch assembly. Over tightening of these may cause failure of assembly and / or cutting operation. The cutter chain should be tight enough so the chain will not slip off of the sprockets but also, not so loose that the upper and lower part of the chain “slaps” together as the cutter moves down the cutting track. If after maintenance of the cutter assembly and chain adjustment, the cutter is still not cutting correctly, make  $\frac{1}{4}$  turn on each of the tension bolts on the “legs” of the clutch mechanism. Ensure that each spring on those bolts are compressed equally. Again, please do not over tighten clutch mechanism.**

**\*Depending on the amount of cuts you make per day, the blade should be flipped over to ensure proper sharpening of the cutter blade. If you make over 50 cuts per day, you should flip the blade over at least once a week. Do not forget to use a Silicone or Teflon spray on the blade to help prevent latex build up on the blade.**

In following these procedures you will find that your cutter will operate to its fullest capabilities and prolong the life of your cutting assembly. If you have any questions concerning these procedures contact the Accu-Cut Service Department at 1-800-222-8288.



## TEST STRIP INSTRUCTIONS

### How to make a test strip:

1. Cut a strip of carpet that is 4 " wide by 13' long.
2. Center your tape measure on strip of carpet.
3. Draw a line at 0 and a line at 12'.
4. DO NOT cut off excess material.

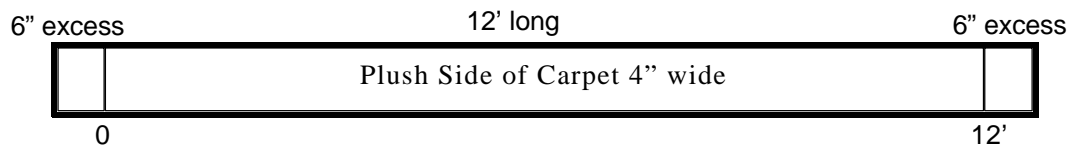

### How to use a test strip:

1. Unwind test strip plush side up, line up the black hold down arm over wheel with 1<sup>st</sup> black line on test strip.
2. Reset counter to zero.
3. Slowly pull test strip across the measuring wheel.
4. Stop at 2<sup>nd</sup> black line, counter should read 12 feet.
5. Repeat the test 3 or 4 times.
6. If measurement is off contact your Accu-Cut Service Representative.

# TROUBLE SHOOTING

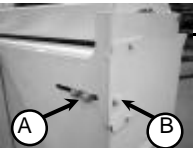
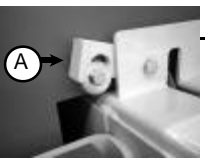
Problem	Solution
Machine will not run at all	<ul style="list-style-type: none"> <li>◆ Is the emergency shut off button down? Lift button and try running machine again</li> <li>◆ Check extension cord connections</li> <li>◆ Check breakers in electrical panel in the building</li> </ul>
PLC lit up, but machine will not run	<ul style="list-style-type: none"> <li>◆ Enter password</li> </ul>
Cutter stops or moves very slowly part way into the cut	<ul style="list-style-type: none"> <li>◆ Sharpen blade</li> <li>◆ Tighten the 2 springs on the cutter unit Use 7/16 wrench.</li> <li>◆ Note: if too tight blade will not spin for sharpening.</li> <li>◆ Check cutter drive belt. To tighten, loosen motor mount bolts and tighten cutter drive belt with adjusting bolt. Retighten motor mount bolts.</li> </ul> 
Cutter makes excessive noise at either end	<ul style="list-style-type: none"> <li>◆ Tighten cutter chain. Use 9/16" wrench. Loosen both lock bolts (A) and tighten chain tension bold (B). Retighten lock bolts (A).</li> <li>◆ Loosen the 2 springs on the cutter unit.</li> </ul> 
Blade is not sharpening	<ul style="list-style-type: none"> <li>◆ Replace sanding disk</li> <li>◆ Move sanding disk closer to blade. Loosen 2 set screws, (Use 5/32" allen wrench), slide hub in and retighten set screws.</li> </ul>
Cutter does not run at all	<ul style="list-style-type: none"> <li>◆ Cutter safety bar must be down for cut to be performed</li> <li>◆ Control panel must be latched in place (A).</li> </ul> 
Roll up arm moves slowly	<ul style="list-style-type: none"> <li>◆ Check air pressure at compressor, should be 110 PSI</li> <li>◆ Check for air leaks</li> </ul> <p>Make sure flow control adjusting screw is unscrewed fully</p>
Carriage movement is too slow or too fast	<ul style="list-style-type: none"> <li>◆ Adjust flow controls of 4th air valve.</li> </ul>
Drive Chain noise	<ul style="list-style-type: none"> <li>◆ Tighten chain: Load side: Loosen bolts of the gearbox and slide gearbox down.</li> <li>◆ Rollup Side: Adjust chain tightener sprocket.</li> </ul> <p>Check for sprocket alignment. Align and tighten sprocket set screws.</p>

Roll up arm is not closing evenly	<ul style="list-style-type: none"> <li>◆ Check chain tension front and back. Tighten chains by loosening bolts on bracket . Using bolt on bottom, pull chain tight, retighten bracket bolts.</li> <li>◆ Add or remove spacer washer on back sprocket.</li> </ul>
Foot control is not working	<ul style="list-style-type: none"> <li>◆ Ensure control panel is latched in place</li> <li>◆ Tighten foot cable.</li> </ul>
Starting the roll up process is difficult	<ul style="list-style-type: none"> <li>◆ Roll up cradle closes too far. Minimum of 3/4" gap between rollers.</li> <li>◆ Adjust gap at clevis.</li> </ul> 

# Certificate of Warranty

## STATEMENT OF LIMITED WARRANTY

BROCKIE INTERNATIONAL, INC. ("BROCKIE") warrants to the original purchaser ("Purchaser") of this ACCU-CUT machine that should it prove defective by reason of improper workmanship and/or material:

- a. **Labor.** For one year from the date of delivery, BROCKIE will provide labor for a warranty repair without charge to Purchaser.
- b. **Parts.**
  - i. DURING THE FIRST YEAR FROM THE DATE OF DELIVERY, BROCKIE will repair or replace, at its option, any defective part without charge to Purchaser for the part. Parts used for replacement will be warranted for the remainder of the original warranty period.
  - ii. DURING THE SECOND YEAR FROM THE DATE OF DELIVERY, BROCKIE will repair or replace, at its option any defective part paying for 66% of the cost of the part. The Purchaser shall be responsible for 34% of the cost of the part.
  - iii. DURING THE THIRD YEAR FROM THE DATE OF DELIVERY, BROCKIE will repair or replace, at its option any defective part paying for 33% of the cost of the part. The Purchaser shall be responsible for 67% of the cost of the part.

1. TO OBTAIN WARRANTY SERVICE, contact Brockie International, Inc. at the address and phone number below. BROCKIE will only pay for warranty service performed by a Brockie International, Inc. authorized technician authorized by BROCKIE to perform warranty service on your machine.

2. Buyer shall have the right to inspect the machine(s) before acceptance or payment. THERE SHALL BE NO IMPLIED WARRANTY WITH REGARD TO DEFECTS WHICH AN EXAMINATION PRIOR TO ACCEPTANCE OUGHT TO REVEAL. Buyer shall accept or reject any machine with three (3) days of receipt by Buyer.

3. THE LIMITED WARRANTY SHALL NOT APPLY TO any defects resulting from, but not limited to: abuse, lack of maintenance, unapproved modifications, overloading, power surges, inadequate power supply including extension cords, misuse, fire, flood or acts of God such as lightning. This limited warranty does not include normal wear and tear of parts or equipment including, but not limited to, belts, blades, blade holder assemblies, and grip tape. BROCKIE reserves the right to repair or replace, at its sole option, any defective part and/or any components, within the warranty period. THERE ARE NO WARRANTIES WHICH EXTEND BEYOND THE DESCRIPTION ON THE FACE HEREOF.

4. BROCKIE WILL SHIP REPLACEMENT PARTS via normal ground freight, pre-paid to the Purchaser during the warranty period. *It is the responsibility of the purchaser to return all defective parts, freight pre-paid, to BROCKIE within 30 days for warranty consideration.* Any extra freight costs for special shipping, such as airfreight or overnight shipping, is the responsibility of the Purchaser.

5. BROCKIE INTERNATIONAL, INC.'S LIABILITY AND PURCHASER'S REMEDIES UNDER THIS WARRANTY SHALL BE SOLELY LIMITED TO THE REPAIR AND/OR REPLACEMENT OF DEFECTIVE PARTS AND SHALL NOT BE LIABLE UNDER ANY CIRCUMSTANCES, FOR CONSEQUENTIAL OR INCIDENTAL DAMAGES, LOST INCOME DUE TO DOWNTIME, PERSONAL INJURIES, DAMAGE TO PERSONAL PROPERTY OR LABOR COSTS.

6. ANY EXPRESS OR IMPLIED WARRANTY NOT PROVIDED HEREIN, AND ANY REMEDY WHICH, BUT FOR THIS PROVISION, MIGHT ARISE BY IMPLICATION OR OPERATION OF LAW, IS HEREBY EXCLUDED AND DISCLAIMED.



**Brockie International, Inc.**  
28114 CR 561  
Tavares, Florida 32778  
352-742-0902 / 800-222-8288