

# ***FASTER FLOORING***

**2024 PRODUCT GUIDE**

**PORTAMIX<sup>TM</sup>**

**MIXING WITH THE BEST**

# YOUR TRUSTED GUIDE FOR THE PERFECT MIX EVERY TIME.

As the flooring contractor, you are the hero (more commonly known as the flooring professional) who arrives on site and doesn't leave until the perfect flooring is completed. Upon completion, you will have a masterpiece that will satisfy your customer and grow your reputation as the one who "knows what he's doing and does it fast!"

Portamix is here to help and guide you in the best mixing methods to ensure you can mix and pour the perfect mix every time.

✓ **MIX FASTER**

✓ **POUR FASTER**

✓ **PROFIT FASTER**

✓ **HOME FASTER**

**Front Cover:** Tradestone Concrete Polishing & Resinous Surfaces Washington DC Self-Leveling Topping

**Inside Page:** PFP Leveling Solutions - Delaware USA Ardex K 530 Decorative Concrete Topping with added recycled granite.



## #MIXINGWITHTHEBEST

### **mix**

*/miks/*

*verb*

gerund or present participle: mixing combine or put together to form one substance or mass.

### **best**

*/best/*

*adjective*

of the most excellent or desirable type or quality.

Pioneering the world's first mobile mixing station in the '90s, Portamix embraced the 'Mixing with the Best' ethos, cementing its role as the trusted go-to advisor in the self-leveling and trowel-down compound mixing industry.

Opting to mix with the best material manufacturers, dealers, and flooring contractors globally, Portamix spearheads the industry, combining innovation and collaboration for consistently swift flooring solutions.

# CORRECT VS INCORRECT MIXING

## CORRECT MIXING GAINS

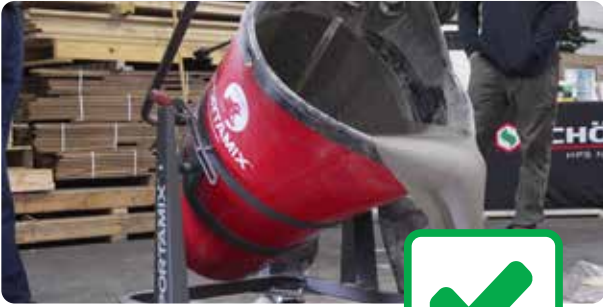

- Full Product Warranty
- Essential Ingredient Blending
- Chemical Reaction As Designed
- 100% Mixing Consistency
- Zero Rework
- Peace of Mind
- Trusted Professional
- Increased Productivity
- Reduced Labor Cost
- Competitive - Win More Projects
- Increased Profitability (Buy that boat!)
- 5-Star Reputation (The Flooring Hero)
- Reduced Pain & Strain
- Go Home Early!

## INCORRECT MIXING PAINS

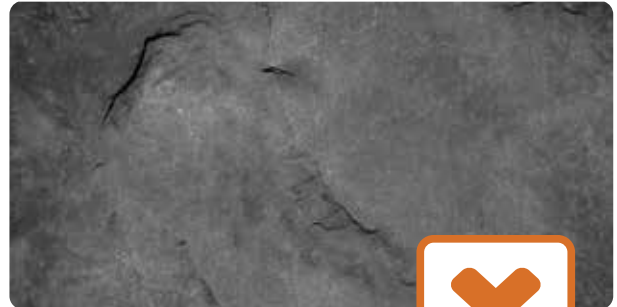

- Product Warranty Null & Void
- Incomplete Mixing
- Potential Curing Issues
- Lumpy & Variable Mixes
- Immediate Remedial Cost - 3x
- Occupied Remedial Cost - 10x
- Public Liability Cost
- Working Harder For Less
- High Labor Costs
- Beaten By Competition
- Low Profitability - No Cash!
- Poor Reputation
- Fatigue & Back Strain
- Long Working Hours (Less family time)



**FIND A DEALER**

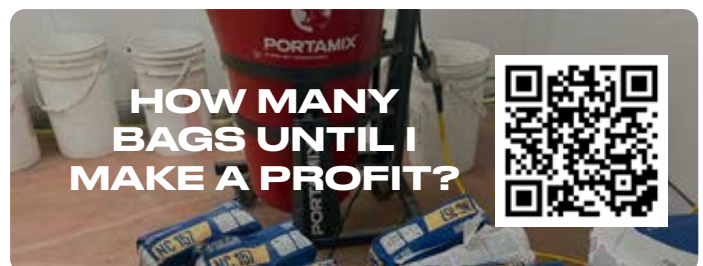

**HOW MANY BAGS UNTIL I MAKE A PROFIT?**



# FASTER FLOORING

## TABLE OF CONTENTS

4



### Self-leveling & Flowable Compound Mixers

- Mega Hippo Mixers
- Pelican Mixers
- Badger Mixer

14



### Trowel-down & Resin-bound Compound Mixers

- Yak Forced Action Mixers

18



### Transport Carts

- Pelican Transport Cart

20



### Hand Mixers

22



### Accessories

27



### Mixer Selection Guide



Image: Abbruzzese Floors Inc - New York USA  
Self leveling cement



## **SELF-LEVELING & FLOWABLE COMPOUND MIXERS**

---

# WHAT CAN THE MEGA HIPPO MIX?

## Anything that is pourable, self-levelling and self-smoothing.

- | Cementitious underlays
- | Decorative topping
- | Self-leveller with bulk fill/aggregate
- | Polyurethane
- | Urethane cement coatings

- | MMA
- | Epoxy coatings
- | Flowing mortar and grout
- | ESD flooring

## DON'T MIX WRONG!

Detailed Mega Hippo mixing instructions.



## HOW-TO-MIX SELF LEVELERS WITH THE MEGA HIPPO

1



Pick your paddle

2



Add all the water or liquid

3



Turn on in low speed

4



Add all but final bag

5



Turn Off, Scrape, Turn On In High Speed

6



Add Final Bag For One Minute

7



Turn Off, Burp

8



Turn On, Mix For Factory Recommended Time





# MEGA HIPPO

## MIXING STATION



### Powerful Drive

Heavy-duty German-made motors with options for heavy viscous material mixing

### Safety First

Safety switch with built-in RCD

### Gen-2 Model

Gen-2 model offers advanced control and balance. See details below.

### Change with Ease

Multistage stop pin to allow easy height motor height adjustment and paddle replacement.

### Handle with Ease

Multi-position handle for well-balanced material transportation and pouring.

### Rugged & Compact Design

The robust, powder coated chassis and cradle will fit through a standard doorway.

### Dust Control

Integrated dust port for dust-free mixing. Optimum performance with the Lid.

### Efficiency Plus

The flexible liner allows for increase efficiencies in both mixing and cleaning.

### Precision Pouring

Moulded pouring spout allows for precise pouring of material without any build-up.

### MEGA Capacity

The huge 22 gallon / 352lbs safe workload limit allows for up to 6 bags per mix.

### Tilt Control

Tilt lever for release and pour control

### Long Life

Hard wearing MDPE cannister for minimal wearing when mixing

### Easy Roll

Heavy-duty 5" wheels provide optimum maneuverability on flat floors, allowing accurate pour and spread of material simultaneously.



**"The Hippo seems like it was designed by the people who do it."**

### KEY FEATURES

- | Mixes, delivers and spreads material quickly with excellent control
- | Handles wide range of construction compounds
- | Easy operation by one person
- | Reduces time, effort and labour costs
- | Thorough mixing, blending and placement without mess
- | Dust extraction port to allow vacuum connection to reduce dust hazard while mixing
- | Easy to clean out



Approximate relative dimensions

### Mega Hippo Gen-II Points of Difference

1. Heavy-duty 2300watt, 3-Speed Motor
2. Integrated T-Bar Handles
3. Higher Pivot & Pour Point

The heavy-duty motor allow continuous mixing of heavier compounds including material with large, decorative chip.

The T-Bar style handles and higher pivot & pour point provides superior balance and higher working levels that gives greater control when maneuvering and pouring heavier materials.







### Put A Lid On It

Safety — reduce exposure to mixing helix  
 Dust control — reduce dust escaping from the canister.  
 Cleanliness — reduce splashing material from leaving the canister



### Dust Control

Reduce dust to a minimum with the integrated 58mm / 2 1/4 inch dust port. With the liner featuring the same port, and the lid contoured to fit, hazardous dusts are minimal.



### Reduce Downtime & Cross Contamination

Resilient, pliable liner is easily cleaned. Alternating liners prevents cross contamination. Extends life of canister. Flexible — easily breakout compound buildup. Ideal for resins, epoxies and other difficult-to-clean materials.



### Wheel Kit Options

F-Series - Easy roll mobility — ideal for flat floors. Allows accurate placement of material — pour and spread at the same time.

X-Series - Ideal for rough terrain. Increased pouring height — pour directly into buckets or carts



### Mega Hippo Gen-2 Option

Increased balance designed to pour heavy, higher viscosity materials with ease and precision.  
 200mm / 7inch higher upper handle and increased balance that gives greater control when maneuvering and pouring.



### Paddle Design & Options – Full & Half Batch

The paddle are designed to lift and shear the product quickly and efficiently, producing a consistent mix and thorough blending of colors and additives.

Full-height paddle is design for 4+ bags Half-height paddle is designed for 1-3 bags

5-6 Bag Mix	3-4 Bag Mix	Rounded Canister	Full Dust Control Lid	Replaceable Liner	Easy Clean	Mix all flowable compounds including decorative chip	3-Year Warranty*
✔	✔	✔	✔	✔	✔	✔	✔

\*3-Year Warranty upon online registration at [portamix.com/warranty-registration/](http://portamix.com/warranty-registration/)

## MEGA HIPPO SPECIFICATIONS AND SELECTOR GUIDE

Order Code	Gen-II Series			Original Series		
	PMHX80HD	PMHX80HD-110	PMHX80W-110	PMHW80-110	PMH80	PMH80-110
Motor Model	PH2516R	PH2516R-110	PH2016WUS	PH2016WUS	PH1816S	PH1816S-110V
Watts	2300	2500	2000	2000	1800	1800
Volts	230-240	110	110	110	230-240	110
RPM (No load)	1 <sup>st</sup> Gear 170 / 2 <sup>nd</sup> Gear 270 / 3 <sup>rd</sup> Gear 390		1 <sup>st</sup> Gear 310 / 2 <sup>nd</sup> Gear 650	1 <sup>st</sup> Gear 310 / 2 <sup>nd</sup> Gear 650	1 <sup>st</sup> Gear 220 / 2 <sup>nd</sup> Gear 670	
Cannister				PH706		
Cannister Lid				PH718		
Liner				PH705		
Mixing Paddle - Full Batch				TW225D - M16 Thread Mount		
Mixing Paddle - Half Batch				TW225 - M16 Thread Mount		
Wheel Series				PH400 - F Series 5" Castor Kit		
Bowl Capacity				85 Litres / 22 Gallons		
Mix Capacity	6x 20kg mix plus water (160kg)			6x 44lbs mix plus water (353lbs)		
Weight	55kg / 121lbs		51.5kg / 114lbs	44.5kg / 98lbs		48kg / 105lbs
Dimensions	mm: 605W x 810D x 1400H in: 23W x 31D x 55H		mm: 605W x 810D x 1300H in: 23W x 31D x 52H	mm: 605W x 750D x 1300H in: 23W x 29D x 52H		mm: 605W x 750D x 1400H in: 23W x 29D x 55H



# PELICAN MIXER



### Powerful Drive

Heavy-duty European-made mixing motor \*PMP80MIX Only

### Safety First

Safety switch with built-in RCD

### Quick-Mount

Heavy-duty bracket mounts the mixer motor to the Pelican for mixing up to 3 bags at once.

### High Rider

Large handle at an increased height allows for precision control and pouring.

### Long Life

Hard wearing MDPE cannister for minimal wearing when mixing.

### Foot Release

Foot activated tilt release lever.

### Rugged & Compact Design

The robust, powder coated chassis and cradle will fit through a standard doorway.

### Dust Control

Integrated dust port for dust-free mixing. Optimum performance with the Lid.

### Precision Pouring

Molded pouring spout allows for precise pouring of material without any build-up.

### Efficiency Plus

The flexible liner allows for increase efficiencies in both mixing and cleaning.

### Fully Loaded

As a transport cart it holds a full 6-bag Mega Hippo \*PMP80 only

### Easy Roll

Rubberised castors provide optimum maneuverability on flat floors allowing accurate pour and spread of material simultaneously.



"Always appreciate a good pour of material that doesn't make you work harder."

**NICK ABBRUZZESE**  
**ABBRUZZESE FLOORS INC**

### KEY FEATURES

- | Mixes, delivers and spreads material quickly with excellent control
- | Handles wide range of construction compounds
- | Easy operation by one person
- | Reduces time, effort and labour costs
- | Thorough mixing, blending and placement without mess
- | Dust extraction port to allow vacuum connection to reduce dust hazard while mixing
- | Easy to clean out

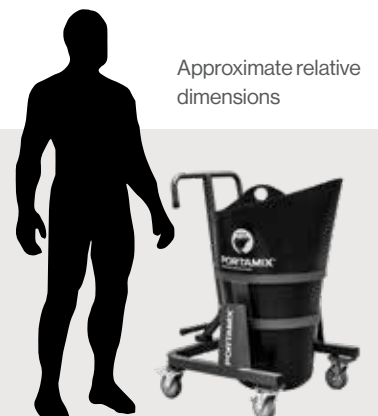

Approximate relative dimensions

# FEATURES



## Ultimate Control

Large, offset, T-shaped handle at an increased height allows for precision control and pouring. Also reducing back pain from long shifts of bending and pouring.



## Dust Control

Reduce dust to a minimum with the integrated 50mm dust port. With the liner featuring the same port, and the lid contoured to fit, hazardous dusts are minimal.



## Reduce Downtime & Cross Contamination

Resilient, pliable liner is easily cleaned. Alternating liners prevents cross contamination. Extends life of canister. Flexible — easily breakout compound buildup. Ideal for resins, epoxies and other difficult-to-clean materials.



## Easy Roll

Rubberised castors provide optimum manoeuvrability on flat floors allowing accurate pour and spread of material simultaneously. Fitted with splatter guards, keeping the bearings clean.



## Powerful Drive

Dual-speed, heavy-duty European motor for material mixing. Includes safety switch with built-in RCD.



## Mixer Options

The Mixer Mount allows a wide number of hand mixers to be used in mixing up to 3 bags. 65mm collar diameter.

3-4 Bag Mix	Rounded Canister	Full Dust Control Lid	Replaceable Liner	Easy Clean	Mix all flowable compounds including decorative chip	3-Year Warranty*

\*3-Year Warranty upon online registration at [portamix.com/warranty-registration/](http://portamix.com/warranty-registration/)

## PELICAN SPECIFICATIONS AND SELECTOR GUIDE

	Pelican Mixer		Pelican Plus
Order Code	PMP80MIX	PMP80MIX-110	PMP80DC
Motor Model	PP1314	PP1314-110	NA
Watts	1250	1150	NA
Volts	230-240	110	NA
RPM (No load)	1 <sup>ST</sup> Gear 170/ 2 <sup>ND</sup> Gear 340		NA
Cannister	PH707		
Cannister Lid	PH718		
Liner	PH705		
Motor Mount	PP650		
Mixing Paddle	TK200P		
Bowl Capacity	85 Litres/ 22 Gallons		
Mix Capacity	3x 20kg mix plus water (80kg) 3x44lbs mix plus water (177lbs)		
Weight	47kg / 104lbs		41kg / 90lbs
Dimensions	mm: 610W x 795D x 1250H in: 24W x 31D x 49H		mm: 610W x 795D x 960H in: 24W x 31D x 37H





# BADGER MINI MIXING STATION



## Handle with Ease

T-bar handle for easy maneuverability and a balanced pour.

## Adjustable Mixing Height

Adjustable mixer mount to allow for the correct paddle replacement and proper mixing.

## Rugged & Compact Design

The robust, powder-coated frame will fit through the smallest doorways and in the back of your van. Two-piece handle for compact transport.

## Zero Lumps

A rounded canister eliminates unmixed compound and a lumpy pour.

## Easy Roll

Large 8"/200mm diameter solid wheels allowing steady transport over door sills and rough ground.

## Mixer Options

Hand mixer mount with variable collar allowing for a wide variety of mixers.

## Mix Right

Includes a large mixing paddle designed to lift and shear the compound quickly and effectively without adding in air. M14 Thread.

## Efficiency Plus

The disposable liner allows for increased efficiencies in both mixing and cleaning.

## Precision Pouring

A molded pouring spout allows for precise material pouring without any build-up.

## Easy Lift & Load

A molded handle for easy loading and unloading.

## Large Capacity

The huge 75-litre canister allows for up to three bags per mix.

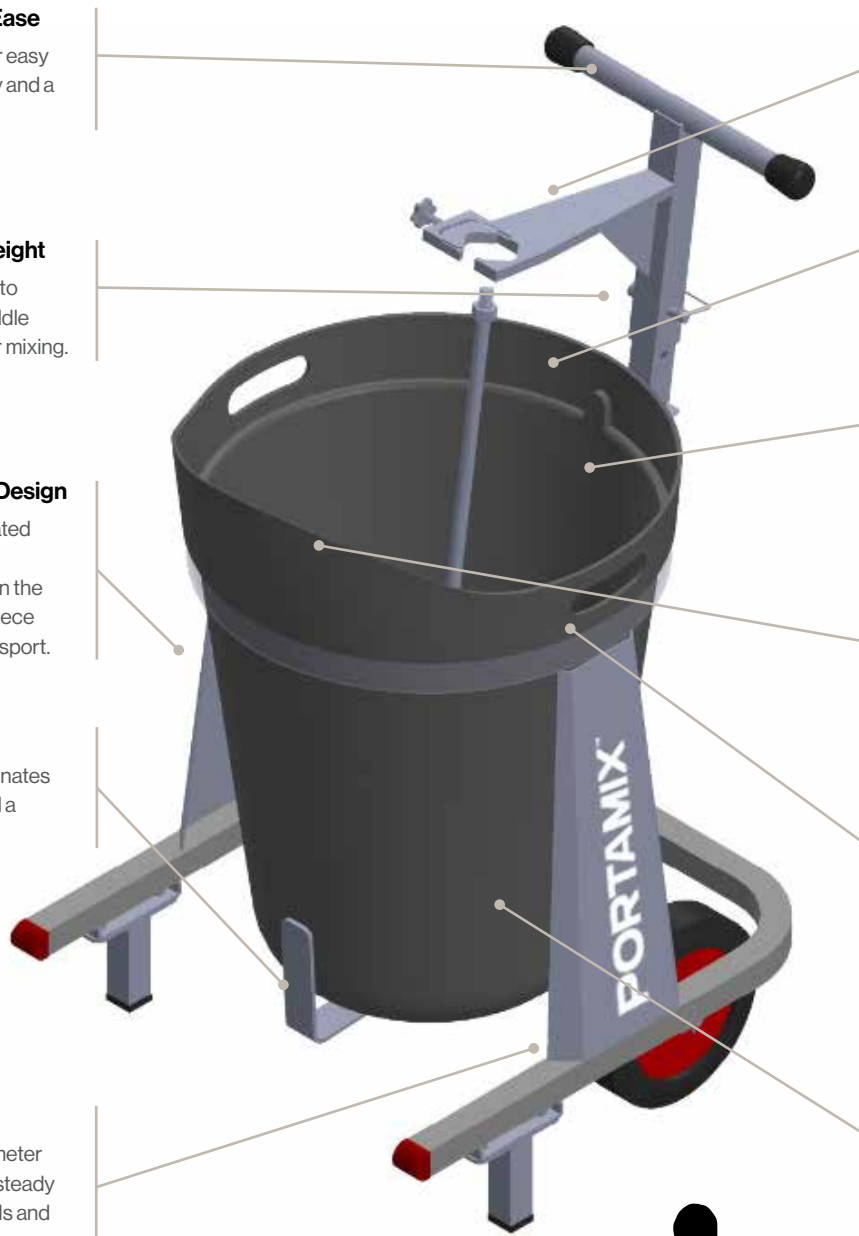

Please Note: Conceptual render may differ from product.

## KEY FEATURES

- | Mixes and delivers material quickly with excellent control.
- | Easy operation by one person
- | Reduces time, effort, and labor costs
- | Compact design for transport and the smaller applications

- | Dust extraction port to allow vacuum connection to reduce dust hazard while mixing
- | Easy to clean out
- | Easy to carry



# FEATURES



## Handle With Ease

A large, offset T-bar handle with adjustable height allows for precision control and pouring. Also reducing back pain from long shifts of bending and pouring.



## Easy Carry

Large, integrated handholds allow for easy lifting and loading/unloading from vehicles.



**COMING SOON**

## Fast Clean Up

The disposable liners prevent the ongoing buildup of dried compound and saves hours of cleaning time. Ideal for resins, epoxies, and other difficult-to-clean products.



## Easy Roll & Stable Design

Large 8"/200mm diameter solid wheels inside a sturdy frame allowing steady transport over doorsills and rough ground.

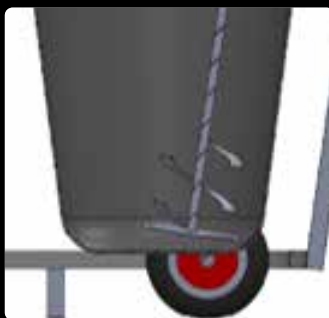

## Mixing Consistency

The correctly angled and placed mixing paddle allows for perfect mixing and blending for a lump-free pour.



## Mixer Options

The adjustable mixer mount allows a wide range of hand mixers to be used to mix up to three bags.

5-6 Bag Mix	Rounded Canister	Dust Control Port	Disposable Liner	Easy Clean	Mix all flowable compounds including decorative chip	3-Year Warranty*

\*3-Year Warranty upon online registration at [portamix.com/warranty-registration/](http://portamix.com/warranty-registration/)

## BADGER SPECIFICATIONS

<b>Order Code</b>	PMB60
<b>Cannister</b>	PB705
<b>Mixing Paddle</b>	TWP160
<b>Bowl Capacity</b>	75 Litres / 20 Gallons
<b>Mixing Capacity</b>	3x 20kg mix plus water (80kg) 3x 44lbs mix plus water (177lbs)
<b>Weight</b>	31kg / 68lbs
<b>Dimensions</b>	mm: 592W x 660D x 1014H in: 23W x 26D x 40H





**TROWEL-DOWN & RESIN-BOUND  
COMPOUND MIXERS**

---



# WHAT CAN THE YAK MIX?

**Anything that is not pourable not self-levelling or self-smoothing.**

- | General purpose mortar
- | Sand & cement renders
- | Cement mortar
- | Masonry mortar
- | Screed – non-self-leveling
- | Finishing mortar

- | Facing plaster
- | Fillers
- | Tile adhesive
- | Plaster
- | Concrete repair materials
- | Expanding concrete
- | Resin-bound gravel





# YAK FORCED ACTION MIXER



### 360 Dust Control

Integrated 360° dust ring for optimized dust control when mixing.

### Safety First

Trip switch stops the motor when lifting the grill lid.

### Swap It Over

Interchangeable bowls – switch between 120 litre /31 gallons & 240 litre / 63 gallons

### Handle with Ease

Large handles on either side of the bowl for transporting and swapping bowls

### Powerful Drive

Heavy-duty, low noise mixing motor for mixing high-viscosity compounds

### Easy Roll

Rugged 6" front castors provide optimum maneuverability. Eliminating the need to tilt and push

### Efficiency

Rugged bag opener for fast loading

### High Capacity

120 litre /31 gallon or 240 litre / 63 gallon

### Power Up

Onboard auxiliary power outlet

### Easy Cleaning

Removable bowl for fast and easy cleaning

### Height Adjustable

Height-adjustable front castors to ensure safe and optimum mixing level.

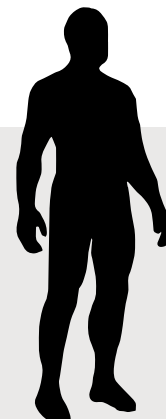

Approximate relative dimensions

### KEY FEATURES

- | Mixes and dispenses resin-bound materials with quiet ease and efficiency
- | Handles a wide range of construction compounds
- | Easy operation by one person
- | Reduces time, effort, and labor costs
- | Thorough mixing, blending, and dispensing without the mess
- | Dust control supplied as standard to minimize dust hazards while mixing
- | Easy-cleaning function with removable bowl



# FEATURES



## Easy Transport

Large, dual rubberized castors at the top of the machine allow for easy loading /unloading from truck deck.

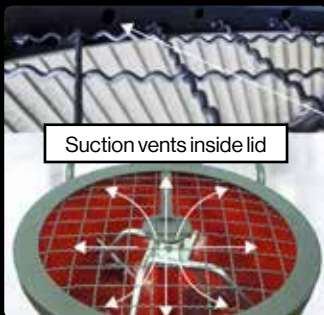

## 360° Dust Control

Reduce harmful dusts to a minimum with the integrated 50mm dust port and 360°, full rim dust ring.



## Powerful Drive

Low-noise motor with heavy-duty gearbox and large spindle for effortless material mixing.



## Power On-board

Auxiliary power outlet for plugging in the vacuum for dust control



## Safety First!

Dual safety feature with a motor trip when the lid is opened and a large emergency STOP button.



## Swap & Clean

5 large bolts for fast and easy removal of the mixing bowl for cleaning or switching sizes.

120 Litre /31 Gallon Mix	240 Litre / 63 Gallon	Quick-Change Bowl	360degree Dust Control Lid	Interchangeable Bowels	4-Wheeled Maneuverability	Mix all non-flowable compounds including decorative chip	3-Year Warranty*
✓	✓	✓	✓	✓	✓	✓	✓

\*3-Year Warranty upon online registration at [portamix.com/warranty-registration/](http://portamix.com/warranty-registration/)

## YAK SPECIFICATIONS AND SELECTOR GUIDE

Description	Yak Mixer 120L		Yak Mixer 240L	
Order Code	PYM10018	PYM10018-110	PYM20018	PYM20018-110
Watts	1800	1800	1800	1800
Volts	230-240	110	230-240	110
RPM (No load)	32		32	
Bowl Capacity	130 Liters / 34 Gallons		267 Liters / 70 Gallons	
Mix Capacity	120 Liters / 31 Gallons		240 Liters / 63 Gallons	
Weight	140kg / 309lbs		158kg / 349lbs	
Width	810mm / 32in		1100mm / 46in	
Depth	1175mm / 46in		1380mm / 55in	
Height	1220mm / 48in		1360mm 54in	





## **TRANSPORT CARTS**

---



# PELICAN TRANSPORT CART



### Precision Pouring

Moulded pouring spout allows for precise pouring of material without any build-up.

### Quick Clean-up

Easy clean canister with no rim or edges

### Fully Loaded

Holds a full 6 bag Mega Hippo mix

### Easy Roll

Rubberise castors provide optimum manoeuvrability on flat floors allowing accurate pour and spread of material simultaneously.



### High Rider

Large handle at an increased height allows for precision control and pouring.

### Long Life

Hard wearing LDPE canister for minimal wearing when mixing

### Foot Release

Foot activated tilt release lever

### Rugged & Compact Design

The robust, powder coated chassis and cradle will fit through a standard doorway.



### Easy Roll

Rubberised castors provide optimum manoeuvrability on flat floors allowing accurate pour and spread of material simultaneously. Fitted with splatter guards, keeping the bearings clean.



### Ultimate Control

Large, offset, T-shaped handle at an increased height allows for precision control and pouring. Also reducing back pain from long shifts of bending and pouring.



### Turn It Into A Mixer!

With the addition of the motor mount, hand mixer, liner and lid, the Pelican quickly earns its place as the mini mixer on-site. Mixing up the three bags, this agile mixer can complete the smaller tasks while the Mega Hippo takes a well-earned break.







## **HAND MIXER**



# HAND MIXER

## EM182R

Designed for mixing many materials including plaster, epoxy, screed, grout and high viscosity adhesives.

Robust industrial power mixer to suit the professional contractor. Ergonomic control handles and electronic variable speed.

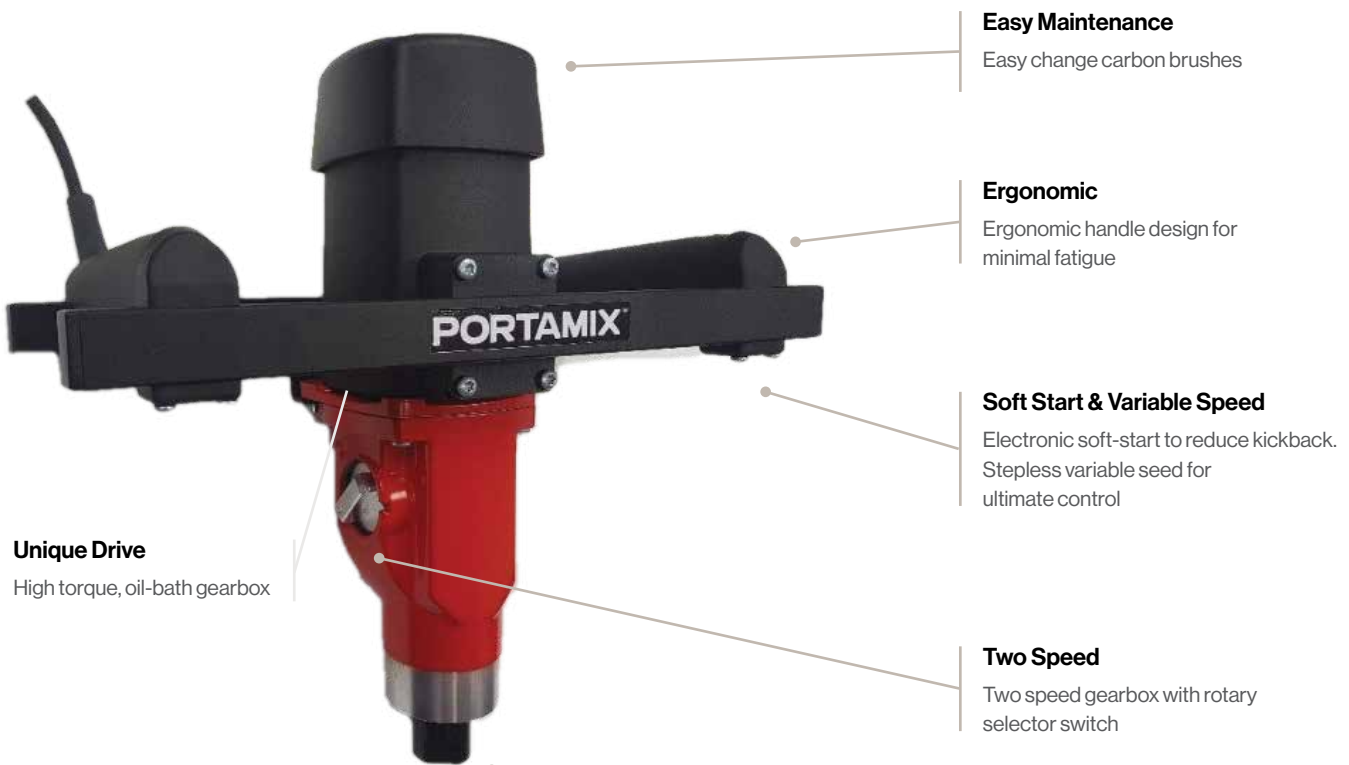

**Unique Drive**  
High torque, oil-bath gearbox

**Easy Maintenance**  
Easy change carbon brushes

**Ergonomic**  
Ergonomic handle design for minimal fatigue

**Soft Start & Variable Speed**  
Electronic soft-start to reduce kickback. Stepless variable speed for ultimate control

**Two Speed**  
Two speed gearbox with rotary selector switch

**Thread Style**  
M14 threaded spindle

Designed for the Pelican DC Mixer



### PORTAMIX HAND MIXER

Order Code	EM182R	EM182R-110
Watts	1800	1800
Volts	220-240	110
RPM (No Load)	1 <sup>st</sup> Gear 0-430 / 2 <sup>nd</sup> Gear 0-850	
Helix maximum diameter	200mm	
Thread	M14	
Weight	7.1kg	



## **ACCESSORIES**

# ACCESSORIES



## CANISTER LINER

- | Allows the mixing of consecutive batches without downtime
- | Avoid flash-cure on fast-setting materials.
- | Eliminate cross-contamination
- | Ideal for resin, epoxy, and other difficult-to-clean materials
- | Suits all Mega Hippo and Pelican models
- | Ideal for mixing different colors - use a liner for each color and save cleaning time

**Code:** PH705



## MEGA HIPPO F-SERIES WHEEL KIT

- | Easy roll mobility — ideal for flat floors.
- | Allows accurate placement of material — pour and spread simultaneously
- | Specially designed wheel covers ensure the castors and bearings remain free of screed splatter.
- | 2 x 5" Braked castors 2x 5" Non-braked castors

**Code:** PH450



## MEGA HIPPO X-SERIES WHEEL KIT

- | Rugged mobility — ideal for rough or exterior terrain
- | Additional height allows for pouring directly into buckets
- | 2 x Pneumatic tires, 1x Axle, 2x Front feet

**Code:** PH500



## PELICAN WHEEL KIT

- | Easy roll mobility — ideal for flat floors
- | Allows accurate placement of material — pour and spread simultaneously
- | Specially designed wheel covers ensure the castors and bearings remain free of screed splatter
- | 2 x 4" Braked castors 2x 4" Non-braked castors

**Code:** PP400



## 50MM DUST PORT HOSE CUFF

- | Suits Mega Hippo with/without liner
- | Suits Pelican Mixer with/without liner
- | Reduce the risk of harmful dust exposure
- | Suits 57mm OD hose

**Code:** PH583





### PORTAMIX STANDARD LID

- | Safety – reduces likelihood of hands and foreign objects getting into the canister
- | Dust control – reduces dust caused by the mixing process escaping from the canister
- | Cleanliness – reduces splashing material from leaving the canister and dirtying your site space
- | Suits PMH80 series Mega Hippos and PMP80 Pelican Cart

**Code:** PH718



### PORTAMIX CHUTE LID

- | Improves operator comfort and
- | Meets health and safety regulations in some countries
- | Safety - Prevent hands or bags from entering the mix
- | Cleanliness – reduces splashing material from leaving the canister and dirtying your site space
- | Suits PMH80 series Mega Hippos and PMP80 Pelican Cart

**Code:** PH723



### MEGA HIPPO STANDARD MOTOR

- | Designed for continuous use
- | High torque, two-speed gear box with slide selector
- | Safety switch with built-in RCD
- | Replaceable carbon brushes
- | M16 Thread mount

**Code:** PH1816S (220-240 volts), PH1816S-110 (110 volts)



### MEGA HIPPO 'WHISPER' MOTOR

- | Compact design with ultra-quiet running
- | Heavy duty 2000 watt
- | Designed for continuous use
- | High torque, two-speed gearbox with rotation selector
- | Safety switch with built-in RCD
- | Replaceable carbon brushes
- | M16 Thread mount

**Code:** PH2016WUS (110 volts)



### MEGA HIPPO HEAVY DUTY MOTOR

- | Heavy duty 23-2500 watt for heavier/high viscosity materials
- | Designed for continuous use
- | High torque, three-speed gear box with rotation selector
- | Safety switch with built-in RCD
- | Replaceable carbon brushes
- | M16 Thread mount

**Code:** PH2516R (220-240 volts), PH2516R-110 (110 volts)

### PELICAN MIXER MOTOR

- | Heavy duty 1800 watt
- | Designed for continuous use
- | High torque, two-speed gearbox with rotation selector
- | Safety switch with built-in RCD
- | Replaceable carbon brushes
- | M16 Thread mount

**Code:** PP1314 (230-240 volts) PP1314-110 (110 volts)



### MEGA HIPPO MOTOR MOUNT

- | Integrated dust shroud to minimize dust and debris falling down the shaft
- | Suits all Mega Hippo motor options
- | Original series – 38mm sq
- | Gen-2 series - 40mm sq

**Code:** PH604 (Original Series) PH606 (Gen-2 Series)



### PELICAN MIXER MOTOR MOUNT

- | Converts the Pelican Cart to a 3-bag mixer
- | Designed for the Hand Mixer EM182R and Pelican Motor PP1314

**Code:** PP650



### MEGA HIPPO HALF BATCH PADDLE

- | Designed with a special spiral ribbon and side bars
- | Lift and shear the product quickly and efficiently
- | Large 225mm diameter eliminates the need for high RPM mixing and helps to prevent flash curing
- | Mixes 2-3 20kg bags
- | M16 Thread

**Code:** TW225/16



### MEGA HIPPO FULL BATCH PADDLE

- | Designed with a special spiral ribbon and side bars
- | Lift and shear the product quickly and efficiently
- | Large 225mm diameter eliminates the need for high RPM mixing and helps to prevent flash curing
- | Mixes 4-6 20kg bags
- | M16 Thread

**Code:** TW225D/16





### PELICAN JETSTREAM PADDLE

- | Designed with a special spiral ribbon and sidebars
- | Lift and shear the product quickly and efficiently
- | Large 200mm / 8" diameter eliminates the need for high RPM mixing and helps to prevent flash curing
- | 800mm / 32" shaft for use in the Pelican DC
- | M14 Thread

**Code:** TK200P



### BADGER PADDLE

- | Designed with a special spiral ribbon and sidebars
- | Lift and shear the product quickly and efficiently
- | Large 160mm / 6.3" diameter eliminates the need for high RPM mixing and helps to prevent flash curing
- | 700mm / 28" shaft for use in the Badger
- | M14 Thread

**Code:** TWP160



### YAK MIXING BOWLS

- | Interchangeable mixing bowls for different-size projects
- | Simple, quick-release design for easy removal and cleaning
- | The replacement bowl kit includes a shovel set, lid, and bowl

**Code:** PY200KIT (240L Bowl Kit), PY100KIT (120L Bowl Kit)



### YAK MIXING SHOVEL

- | Replacement shovel set

**Code:** PY200SS (240L Bowl Shovel), PY100SS (120L Bowl Shovel)



### MARGIN TROWEL

- | Designed for scraping canister sides
- | 6x2" ground blade
- | Ergonomic rubberized handle

**Code:** PCT062







### CLEANING BRUSH

- | Designed for cleaning mixing stations
- | Nylon stock and polypropylene bristles

**Code:** PCB010



# MIXER SELECTION GUIDE

Compound	Yak Mixer	Mega Hippo Mixer	Pelican Mixer	Badger Mixer	Hand Mixer
					
<b>Cement Mortar</b>	X				X
<b>Cementitious Underlays</b>		X	X	X	X
<b>Concrete Repair Compound</b>	X				X
<b>Decorative Topping</b>		X	X	X	X
<b>Drywall Plaster</b>	X				X
<b>Epoxy Resins</b>	X	X	X	X	X
<b>ESD Flooring</b>		X	X	X	X
<b>Expanding Concrete</b>	X				X
<b>Finishing Plaster</b>	X				X
<b>Flowing Mortar and Grout</b>		X	X	X	X
<b>General Purpose Mortar</b>	X				X
<b>Masonry Mortar</b>	X				X
<b>MMA</b>		X	X	X	X
<b>Polyurethane</b>		X	X	X	X
<b>Resin-bound gravel</b>	X				
<b>Sand/cement renders</b>	X				X
<b>Screed</b>	X				X
<b>Self-leveller with bulk fill/ aggregate</b>		X			
<b>Self-levelling compounds</b>		X	X	X	X
<b>Terrazzo Flooring</b>	X	X	X	X	
<b>Tile Adhesive</b>	X				X
<b>Tile Grout</b>	X				X
<b>Urethane Cement Coatings</b>		X	X	X	X



# PORTAMIX™

MIXING WITH THE BEST

New Zealand Head Office

+64 6 399 1100

United States of America Office

+1 612 389 9343

United Kingdom Office

+44 3300 271 880

E: [sales@portamix.com](mailto:sales@portamix.com)

W: [portamix.com](http://portamix.com)

[portamix.com](http://portamix.com)